



Quadrifoglio
S I S T E M I  D'ARREDO

I - 31040 Mansuè (Treviso) ITALY - Via Cornarè, 12 - Basalghelle
Tel. +39 0422756025 r.a. - Telefax +39 0422756028 - <http://www.quadrifoglio.com> - info@quadrifoglio.com

x•time work

programmi
direzionali integrabili
in melaminico e cristallo

modular

*managerial lines
in melamine and glass*



03 x•time work

43 x•time work glass

61 finiture/*finishes*





Design, innovazione, versatilità, ecologia,
esclusività, queste sono le caratteristiche
di X•Time Work.

*Design, innovative, versatility, ecology,
exclusivity are the characteristics
of X•Time Work.*









Il particolare design che caratterizza il programma rende l'insieme unico ed inimitabile.

The particular design makes the difference of this program, render the model in a rare and inimitable style.









La scelta dei materiali è stata molto accurata e attraverso intelligenti combinazioni danno vita ad un insieme gradevole e stimolante.

The material choice is very accurate and diligent combinations give life to a comfortable and stimolant line.













La versatilità di X•Time Work permette di trasformare l'ufficio secondo ciò che la situazione richiede.

X•Time Work's versatility allows to change the office for each situation.







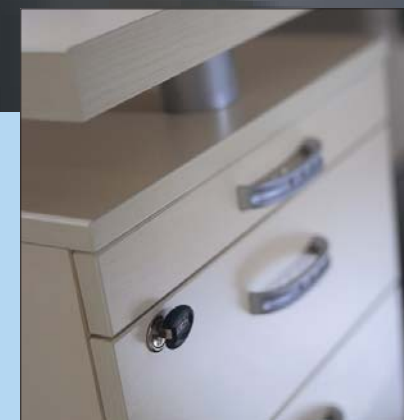



Contenitori componibili di diverse misure:
a giorno, con ante piene, ante a vetro,
con telaio, cassetti e vani attrezzati
con appendiabiti.

*Componible storage units of various
dimensions/ open front, wooden doors,
framed glass doors, drawers, components
with coat-hangen.*







x•time work glass





Le scrivanie in vetro temperato sono in grado di suscitare emozioni senza trascurare la ricerca di forme significative, figurative, caratterizzate.

The directional desk in tempered glass give softy emotions, forfeiting search for a meaniungful, characterised and figurative form.













Una linea pulita, unita all'eleganza dei mobili
contenitori per un'ufficio direzionale
di alto livello.

*Clean line, combined with all the elegance
of the storage units for a high level
executive office.*





finiture
finishes



A

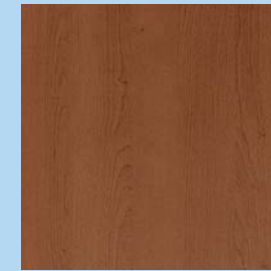

B



D



E



C

nobilitati
melamine

A noce castiglia
walnut

B ciliegio
cherry

C acero
maple

E alluminio
aluminium

glass
glass

D cristallo
glass



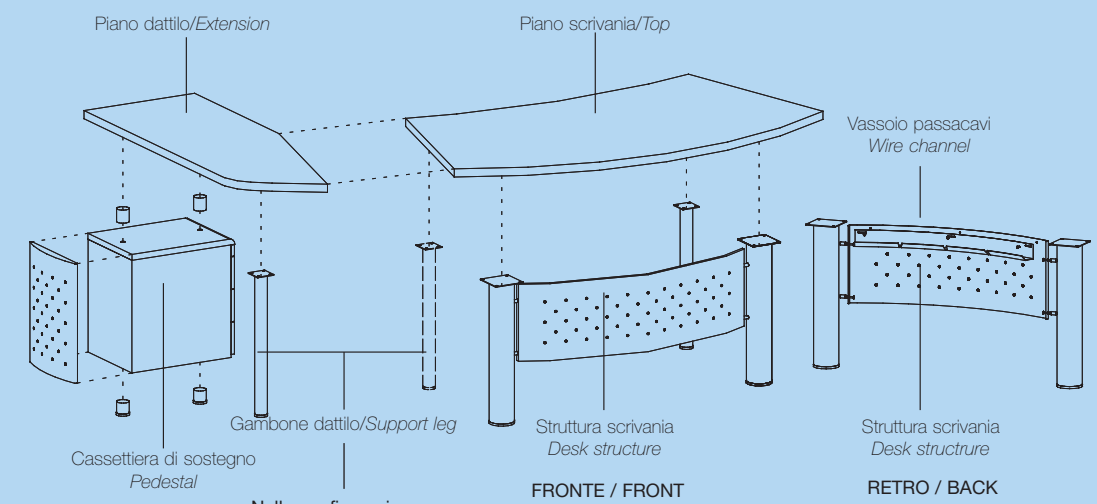
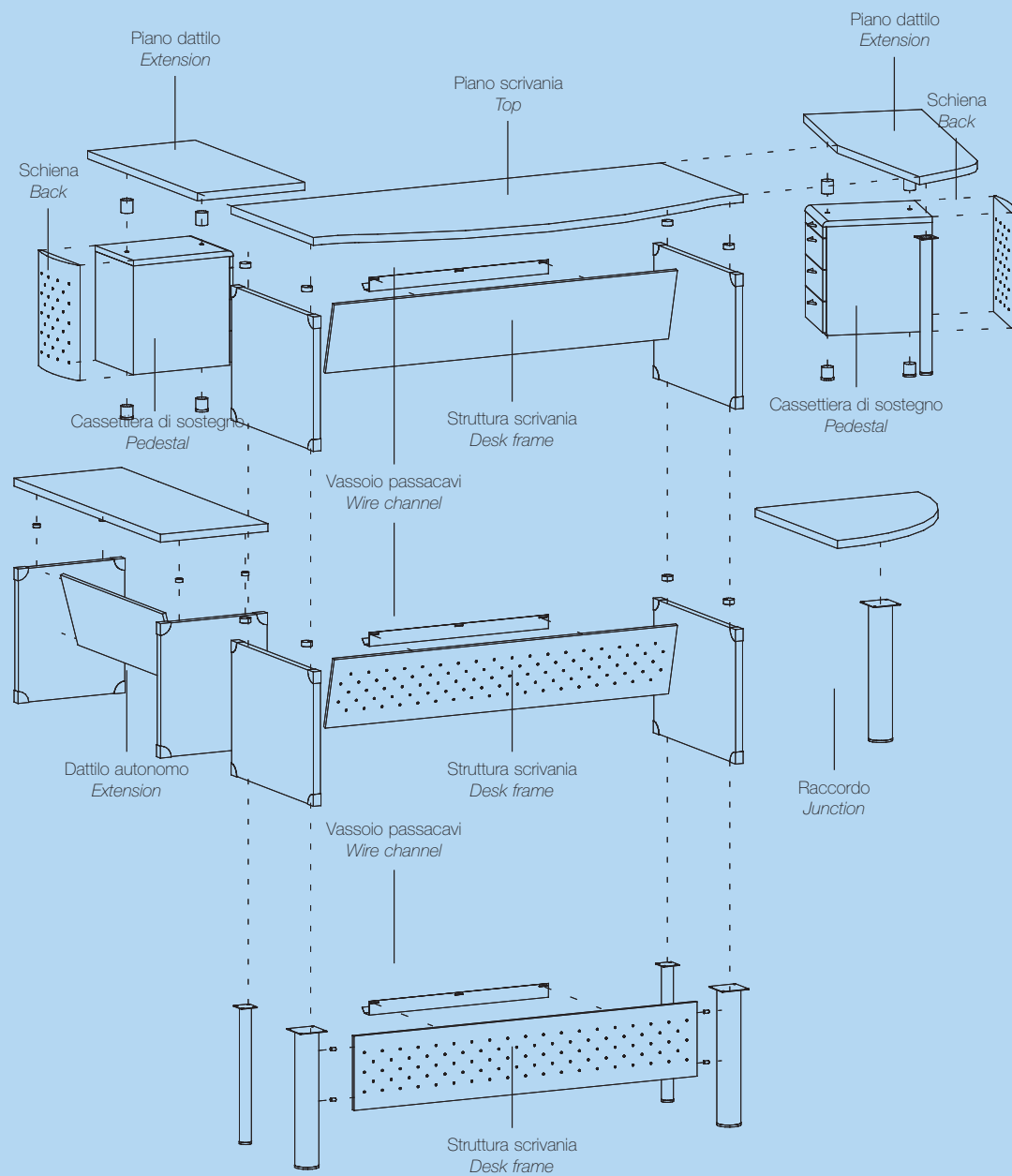

Nella configurazione scrivania/dattilo il gambone viene tolto per rendere più funzionale il posto di lavoro.
 In case of desk + extension this support leg is taken off to make the work place more comfortable.

contenitori/wall unit

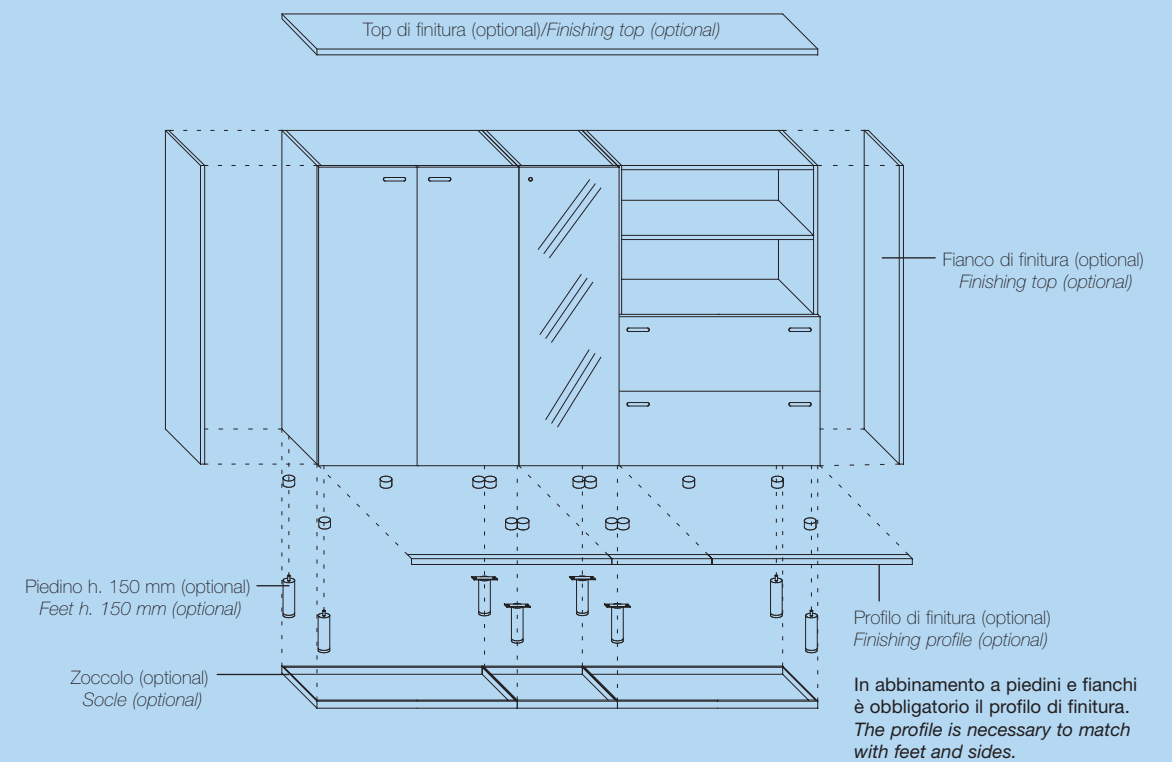

x•time work glass

(Tutti i piani sono in cristallo temperato e acidato)
(All tops are in tempered and etched cristal)

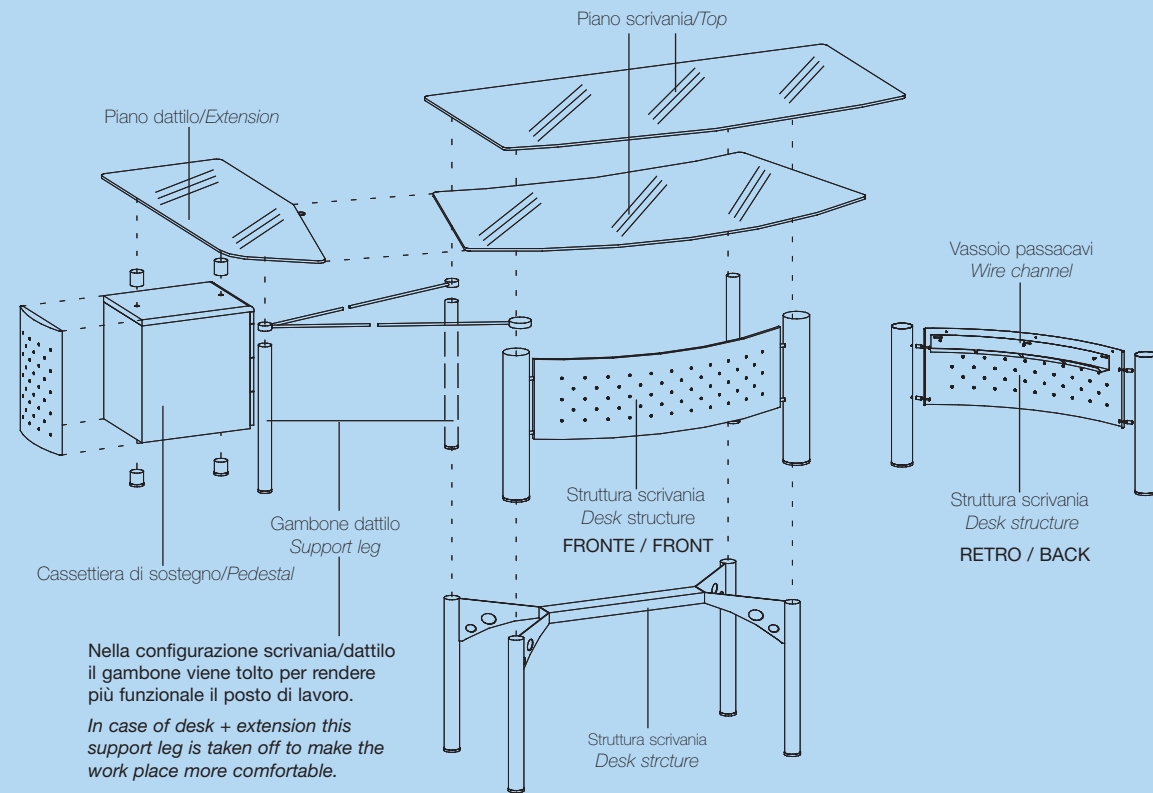

x•time work

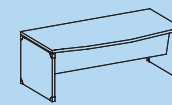

FOSC180
180x101xh. 73,5
FOSC200
200x101xh. 73,5

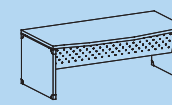

FOSC181
180x101xh. 73,5
FOSC201
200x101xh. 73,5

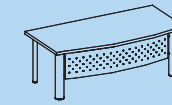

FOSM180
180x101xh. 73,5
FOSM200
200x101xh. 73,5

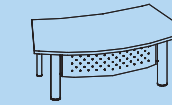

FOSS180
180x108xh. 73,5
FOSS200
200x113xh. 73,5

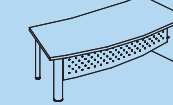

FOAS22S
227x110xh. 73,5
FOAS22D
227x110xh. 73,5



FODSDX0 DX / RIGHT
180x60xh. 73,5
FODSSX0 SX / LEFT
180x60xh. 73,5



FODA100
100x60xh. 73,5

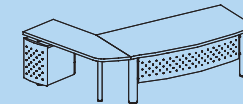

FOSM180D DX / RIGHT
264x198xh. 73,5
FOSM200D DX / RIGHT
284x198xh. 73,5
FOSM180S SX / LEFT
264x198xh. 73,5
FOSM200S SX / LEFT
284x198xh. 73,5

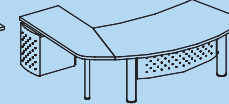

FOSS180D DX / RIGHT
263x197xh. 73,5
FOSS200D DX / RIGHT
283x197xh. 73,5
FOSS180S SX / LEFT
263x197xh. 73,5
FOSS200S SX / LEFT
283x197xh. 73,5

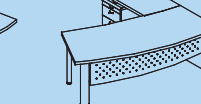

FOAD22D DX / RIGHT
227x211xh. 73,5
FOAD22S DX / RIGHT
227x211h. 73,5

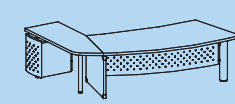

FOAD23D DX / RIGHT
290x211xh. 73,5
FOAD23S DX / RIGHT
290x211xh. 73,5

x•time work glass

(Tutti i piani sono in cristallo temperato e acidato) / (All tops are in tempered and etched cristal)

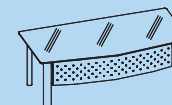

FESC180
L.180xP.101xH.73
FESC200
L.200xP.101xH.73

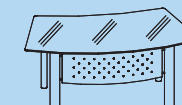

FESS180
L.180xP.108xH.73
FESS200
L.200xP.113xH.73

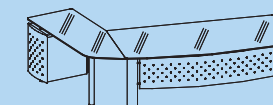

FESC180D
L.263xP.197xH.73
FESC180S
L.263xP.197xH.73

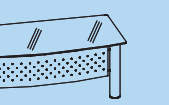

FESC200D
L.283xP.197xH.73
FESC200S
L.283xP.197xH.73



FESS180D
L.216xP.208xH.73
FESS180S
L.216xP.208xH.73

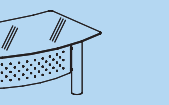

FESS200D
L.236xP.214xH.73
FESS200S
L.236xP.214xH.73

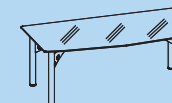

FESC181
L.180xP.101xH.73
FESC201
L.200xP.101xH.73

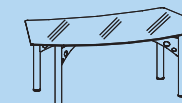

FESS181
L.180xP.108xH.73
FESS201
L.200xP.113xH.73



FESC181D
L.263xP.197xH.73
FESC181S
L.263xP.197xH.73



FESC201D
L.283xP.197xH.73
FESC201S
L.283xP.197xH.73

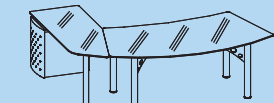

FESS181D
L.216xP.208xH.73
FESS181S
L.216xP.208xH.73

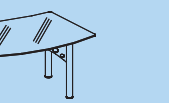

FESS201D
L.236xP.214xH.73
FESS201S
L.236xP.214xH.73

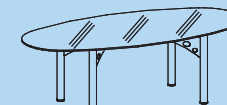

FETR230
L.230xP.110xH.73



FETR231
L.230xP.110xH.73

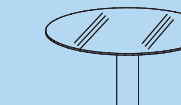

FETC12C
L.120xP.120xH.73

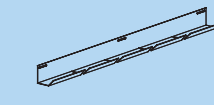

FECN180
L.165xP.5xH.5



IDCA003
42x56xh. 56



IDCA002
42x56xh. 56

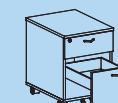

IDCA001
42x56xh. 56



IDCAC03
42x56xh. 63

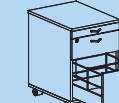

IDCAC02
42x56xh. 63

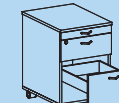

IDCAC01
42x56xh. 63

contenitori/wall unit

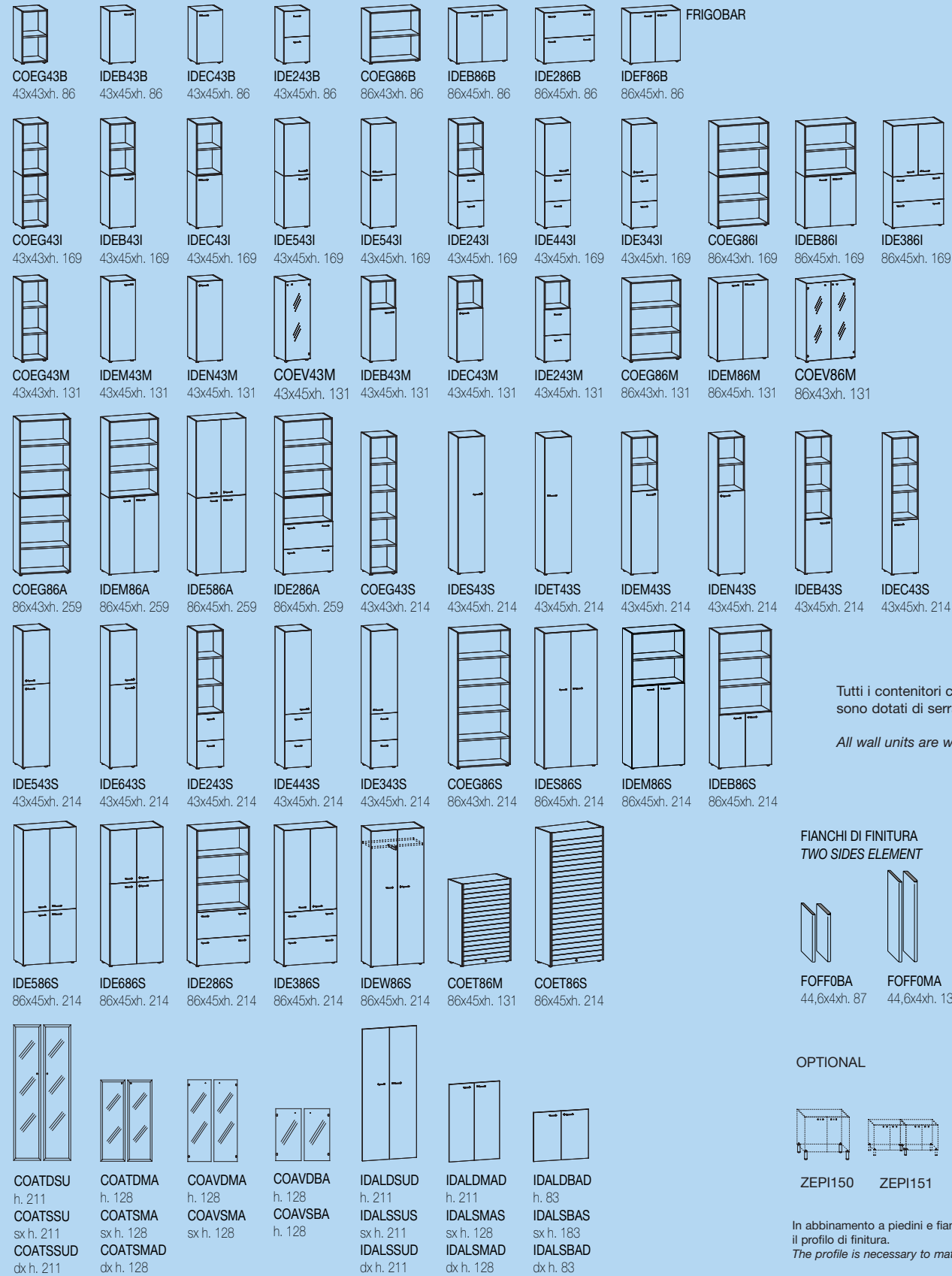

Tutti i contenitori con ante legno sono dotati di serratura.

All wall units are with lock.

FIANCHI DI FINITURA
TWO SIDES ELEMENT

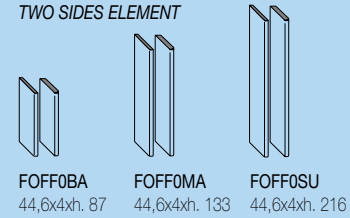

OPTIONAL

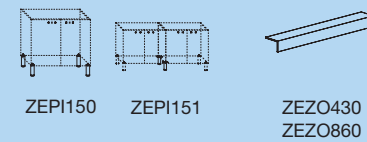

In abbinamento a piedini e fianchi è obbligatorio il profilo di finitura.
The profile is necessary to match with feet and sides.

ZOCOLO / SOCLE



TOP DI FINITURA / FINISHES TOP

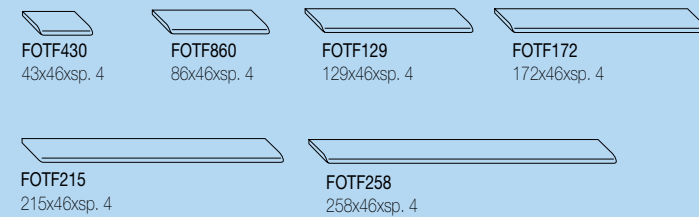

FINITURE / FINISHES: NOCE CASTIGLIA - WALNUT
ACERO - MAPLE
CILIEGIO - CHERRY

Accessori: Consultare listino prezzi / Accessories: Consult price-list
Consultare il listino per le caratteristiche tecniche / Consult price-list for technical carateristics.

ringraziamenti

grafica:

Explano

fotografia:

DOT 6

art buyer:

Carla Bernardis

fotolito:

Sartori Group s.r.l.

stampa:

Grafiche V. Bernardi s.r.l.

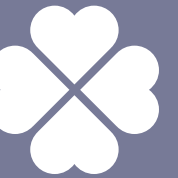



Quadrifoglio
S I S T E M I  D'ARREDO

I - 31040 Mansùe (Treviso) ITALY - Via Cornarè, 12 - Basalghelle
Tel. +39 0422756025 r.a. - Telefax +39 0422756028 - <http://www.quadrifoglio.com> - info@quadrifoglio.com

x•time work